

Cantilever Details

Cantilever with wall load: Wood Web

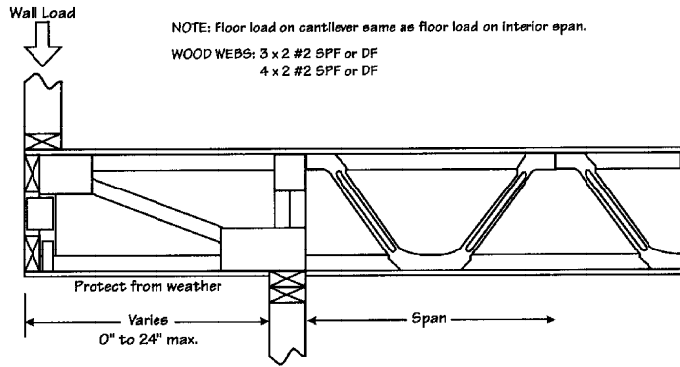

Cantilever for Brick

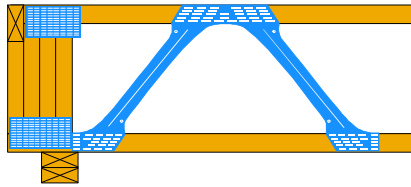

2-Ply Floor Truss Detail

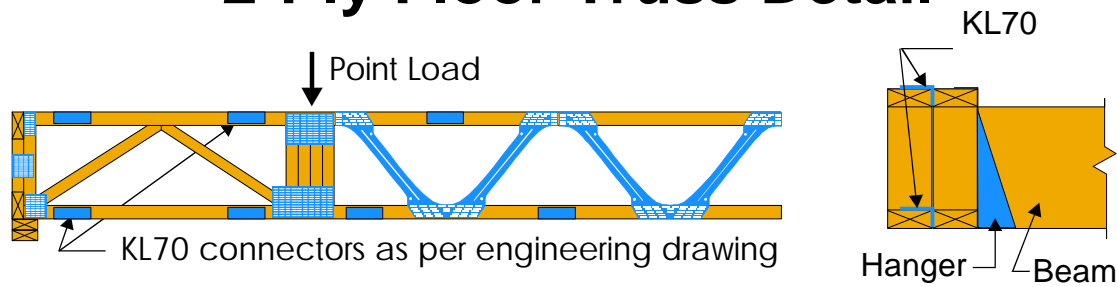

Metal Web Floor Truss System

C.C.M.C acceptance No. 12691-R

IMPORTANT: These guidelines are offered to the user to help with proper installation of the system and insure the structural integrity of the finished product. These recommendations are presented only as a general guide. In some instances additional precautions may be required. For more information contact your MiTek Distributer.

IMPORTANT:

- Store the floor trusses in a vertical position and protect them from prolonged contact with the ground or exposure to extreme weather.
- Install the 2x6 strongbacks at the locations specified on the installation plan before walking on the floor trusses.
- Do not store construction materials that exceed design loads on the floor.
- Glue and nail the subfloor to the floor trusses.

19.2" o/c SPACING (5 spaces @ 19.2" = 8'-0")

Floor Truss No.	Dist. from End	Floor Truss No.	Dist. from End
1	19 3/16"	9	172 13/16"
2	38 3/8"	10	192"
3	57 5/8"	11	211 3/16"
4	74 13/16"	12	230 3/8"
5	96"	13	249 5/8"
6	115 3/16"	14	268 13/16"
7	134 3/8"	15	288"
8	153 5/8"	16	307 3/16"

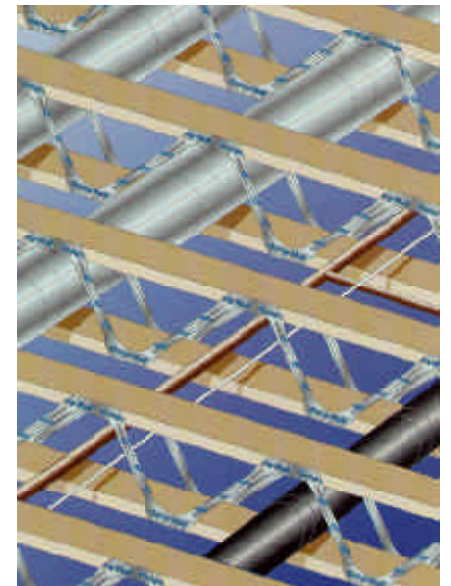

MiTek Canada, Inc.

P.O. Box 1329, 100 Industrial Road,
Bradford, Ontario, Canada, L3Z 2B7
Phone: (905) 775-5337
Toll Free: 1-800-268-3434

<http://www.mitek.ca>

Your Authorized MiTek® Distributer

DO NOT CUT OR REMOVE METAL "V" WEBS

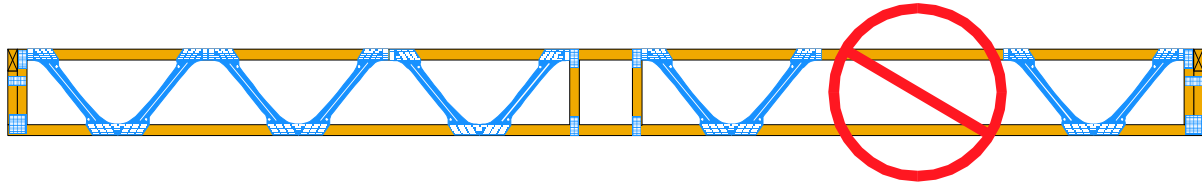

DO NOT CUT, NOTCH, OR DRILL TOP OR BOTTOM CHORDS

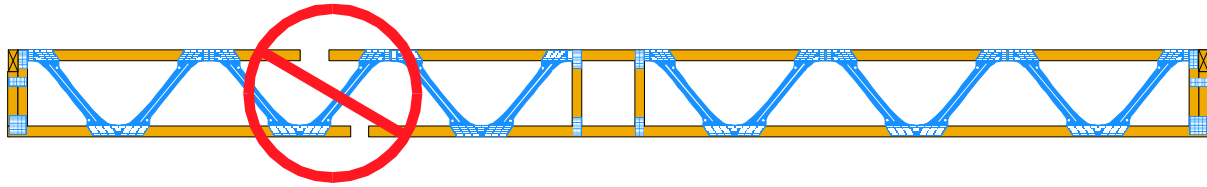

BOTTOM CHORD BEARING DETAILS

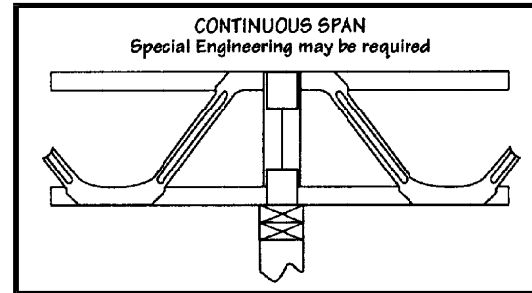
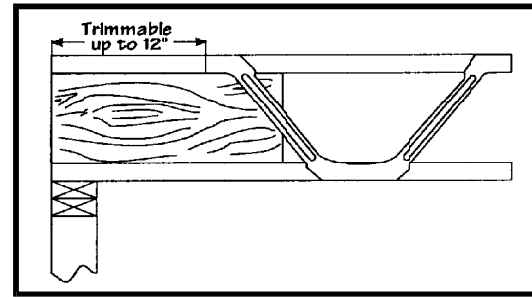
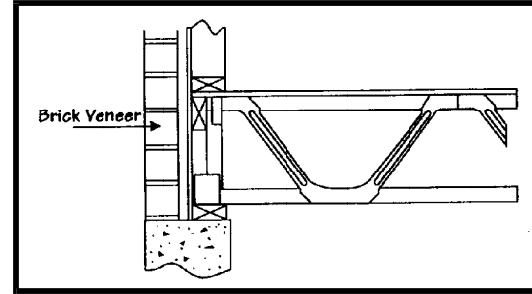

TOP CHORD BEARING DETAILS

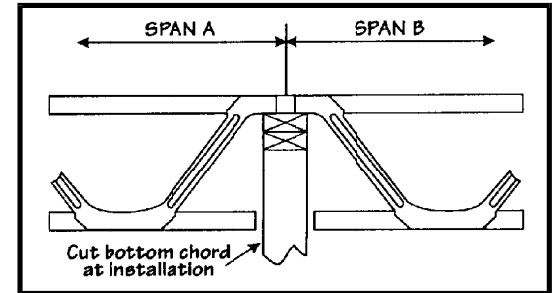
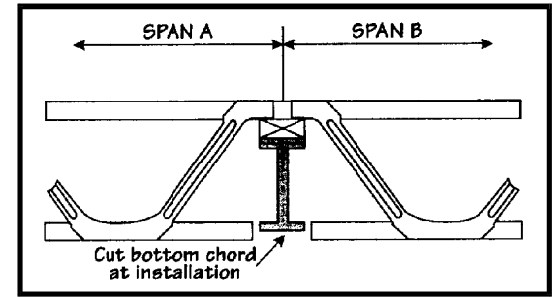
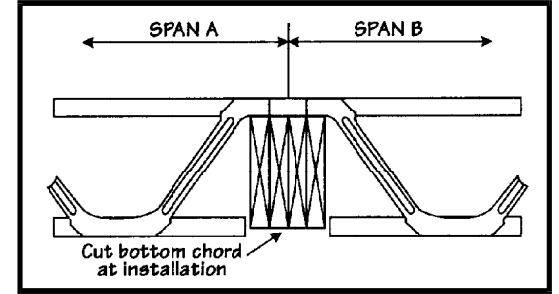

IMPORTANT STRONGBACK INFORMATION:

STRONGBACK BRIDGING DETAILS

To insure the proper performance and structural integrity of the floor system, the following 2x6 strongbacks are **REQUIRED**:

Span	Strongback
0'-0" to 7'-0"	None Required
7'-0" to 14'-0"	2x6 at midspan
Over 14'-0"	2x6 at 7'-0" o/c max.

TYPICAL SPLICE FOR STRONGBACK

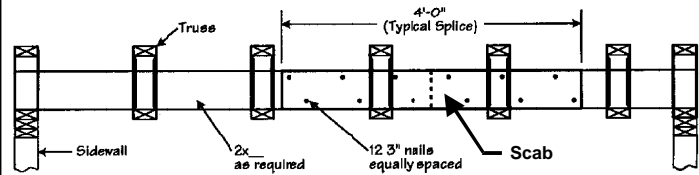

STRONGBACK FASTENING:

- Method A:** Screw to bottom chord with 1 - 3" - #8 screw.
- Method B:** Nail to vertical post below metal web, with 3 - 3" spiral nails.
- Method C:** Nail to vertical post above metal web, with 3 - 3" spiral nails. (1x3 strapping at 7'-0" o/c required for bottom chord)

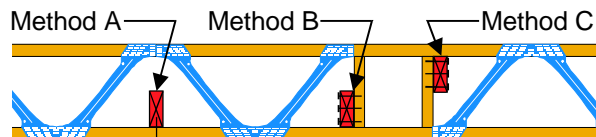

IMPORTANT:
The metal web must overlap bearing by a minimum of 1" for the top chord bearing detail.

